



# NSM V MP3

## Hard Disk MP3 Player For NSM ES-V.1 CD Jukeboxes



- Works with all laptop/notebook HDD's
- Supports all layer-III (MP3) encodings
- Variable or fixed bit rates to 320 Kbps
- Detects master/slave drive setting
- Automatic power down on no activity

The NSM5MP3 is a micro-computer based hard disk player that replaces the entire CD player mechanism in your NSM ES V.1-CD technology model jukebox. The hard disk player works with any jukebox that uses the MBC III CD Changer unit or has the ES-V.1 EPROM Part # 178 238 installed. This includes models Country 2000, Digital Thunder, Emerald Ice, Gemstar, Heritage, Juke 2000, Performer Grand 2000, Performer Wall 2000, Sapphire, Sapphire Midnight and others. The NSM5MP3 player is totally self contained and does not require any programs on the hard disk to operate.

Installations a snap! Only three connections, the 4pin audio connector to your amplifier, an 8pin communication connector to your Control Unit and a ground wire. The player takes only seconds to install, without any modifications to the jukebox. Best of all, Maintenance free... no skipping, no mechanical wear, no adjustments and never needs cleaning or lubrication.



A.u.S. Spielgeräte GesmbH  
Scheydgasse 48 A-1210 Wien  
Tel. +43-1-271 66 00 Fax.+43-1-271 66 00 75  
E-mail: [verkauf@aus.at](mailto:verkauf@aus.at)  
<http://www.aus.at> <http://www.garlando.at>  
Öffnungszeiten: Mo-Do 9-18 und Fr. 9-17 Uhr

**TEL: +43-(0)1-2716600**  
**FAX: +43-(0)1-271660075**  
**Email: [verkauf@aus.at](mailto:verkauf@aus.at)**  
**Web: [www.aus.at](http://www.aus.at)**



## MP3-DSP Kit Contents

Your NSM5MP3 kit comes with a USB 2.0 external HDD circuit board, MP3-DSP digital music player circuit board, USB connector cable for your PC, connector cables for your NSM jukebox, enclosure, power supply, storage pouch and a CDROM with installation software for Windows 98SE, ME, 2000 & XP.

**The hard disk drive is NOT included.**

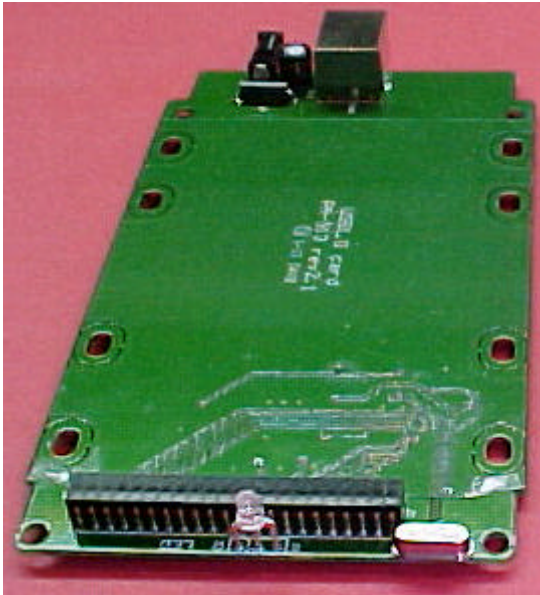

This is your USB external HDD circuit board. When assembled with your disk drive and plugged into the USB port, it will add a drive letter to your computer and allow you to transfer files between your PC and the disk drive.

Using Windows Explorer, clear all files from your disk drive. Create 100 new folders for each of the CD's. The first two letters of each folder name must begin with the two digit disc number (00, 01, 02, ... 97, 98, 99). The following letters can be any name or description you choose. Within each folder drag & drop your MP3 song files. The first two letters of the file name must begin with the two digit track number, 01 to 99.

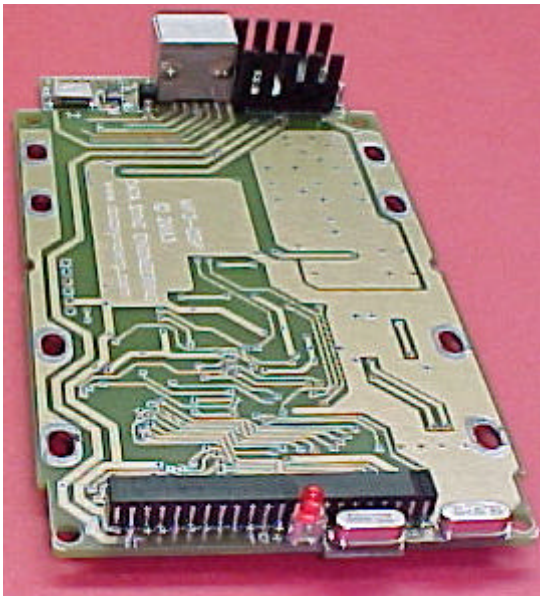

This is your MP3 digital subsystem player circuit board. When assembled with your disk drive, you have a complete music player system.

The NSM5MP3 provides CD changer emulation of 100 discs, with each having a maximum of up to 99 tracks.

## DISCLAIMER – PLEASE READ

The NSM5MP3 kit was developed for jukebox owners for non public performance use. We do not supply jukebox licenses and do not have any knowledge of what is required. It is the jukebox owners responsibility to obtain all applicable licenses for public performance of copyright music.



## Assembling The Hard Disk Drive



The hard disk drive has two sets of connector pins. 43-pins on the left side and 4-pins on the right.



Position the disk drive onto the circuit board then align the left side pins with the connector.



Slide the disk drive forward into the connector. The 4-pins on the right are not used.

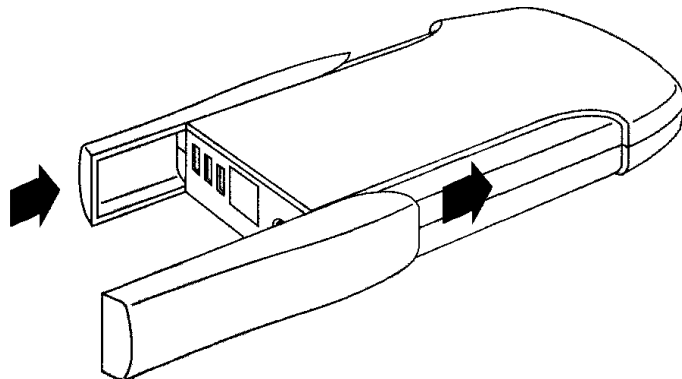
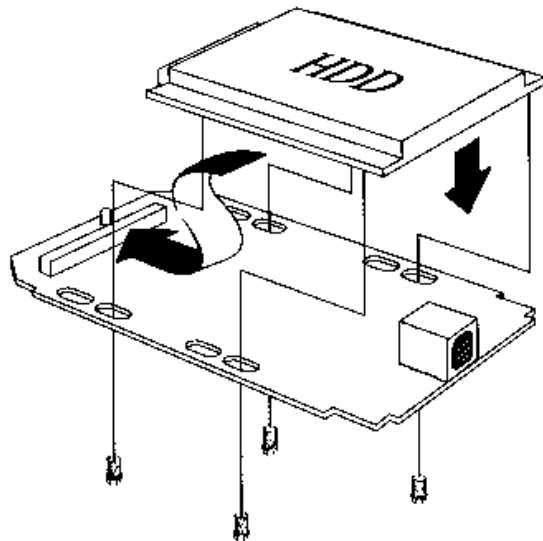
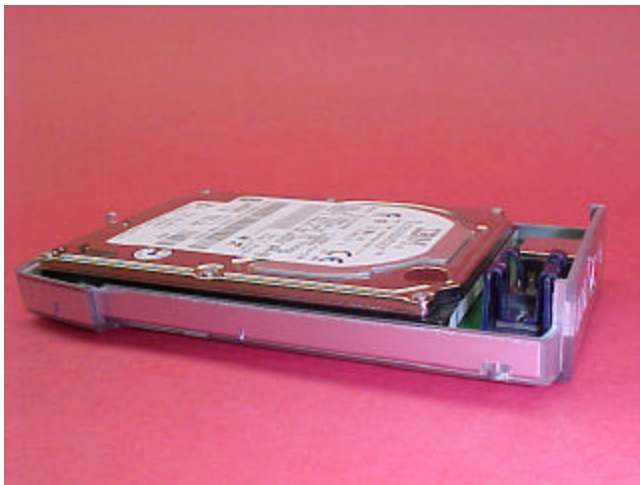





# Optional Compact Flash Card Adapter

The 44-pin IDE adapter allows Compact Flash memory card usage. Works with FAT32 formatted cards having a capacity of 512MB and up.

Approximate song capacities:

CF Size	@128 Kbps	@192 Kbps
512MB	128	102
1GB	250	200
2GB	500	400
4GB	1,000	800
8GB	2,000	1,600

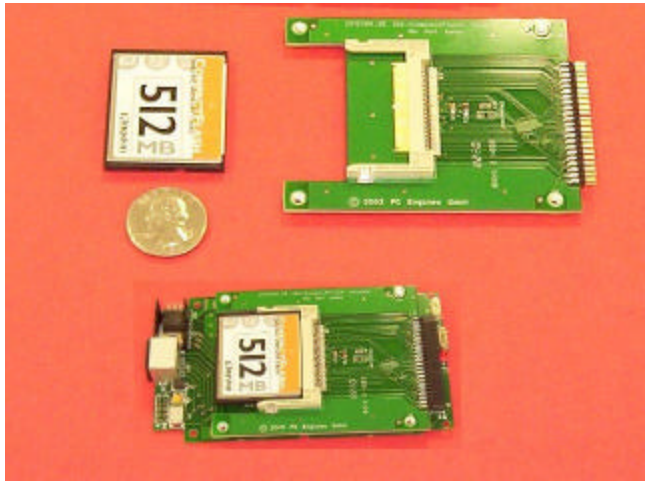

Insert the memory card into the adapter then plug the adapter into the 44-pin IDE connector.

# Creating New Folders for Disc Numbers

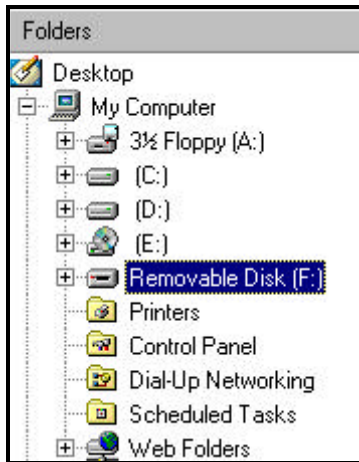

Assemble your disk drive to the USB external HDD board.

Open **Windows Explorer**

Plug in the external HDD USB cable into your computer.

Within a few moments, a new disk drive letter should appear. For this example we see "Removable Disk F:"

**If you did not see a new disk drive letter, follow the instructions in your USB manual about setting up your new disk drive or you can visit [www.cdadapter.com](http://www.cdadapter.com) and go to the FAQ section.**

To create a new folder ...

Single click the new drive letter to hi-lite, Click **File | New** Then click on **Folder**

You should see a **New Folder** name.

Change the name ...

The first two letters must be your disc number from 00 to 99. The following letters can be any text you choose.

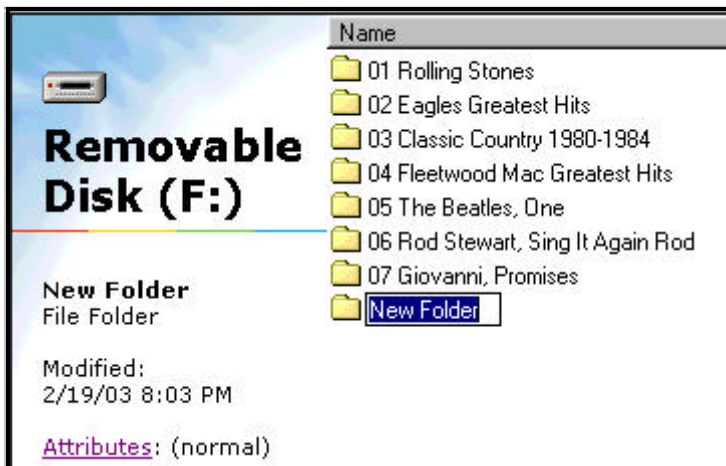



## Drag & Drop Your MP3 Song Files

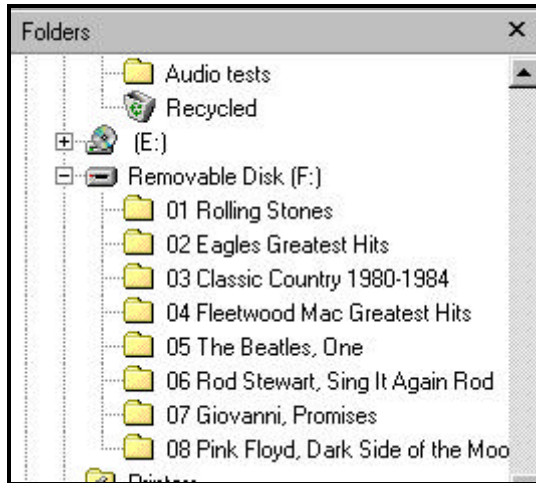

Select the disk and directory for your source of MP3 song files then click the + at "Removable Disk (F:)" to expand the folders.

If you wish to store the entire set of songs, click on the first song at the top, scroll down to the last song, hold down the SHIFT key then click the last song. The entire list should be hi-lighted. Move your mouse over the list then hold down the left mouse button and drag the list to your F: drive folder.

If you wish to store a single song, place your mouse over the song then hold down the left mouse button and drag it to your F: drive folder.



## Setting the Selection Position of Your Songs

Previously, folders were numbered to identify disc positions, here, MP3 song names must be numbered to identify their track position. Most MP3 "rippers" or "extractors" will provide this track numbering feature for you. All characters after the two digit track number are ignored and can be any text you choose. Just like for CD's, you must have sequential track numbers, you can not have skipped sequences.

MP3 song files can be changed at any time, simply delete the old file and insert the new one.



If you need to change or add the selection position number of a song, place the mouse over the song then right click and select **Rename**.

Position your mouse to the start of the song name then left click. You should see a blinking cursor waiting for you to edit.

# NSM ES-V.1 Jukebox Installation

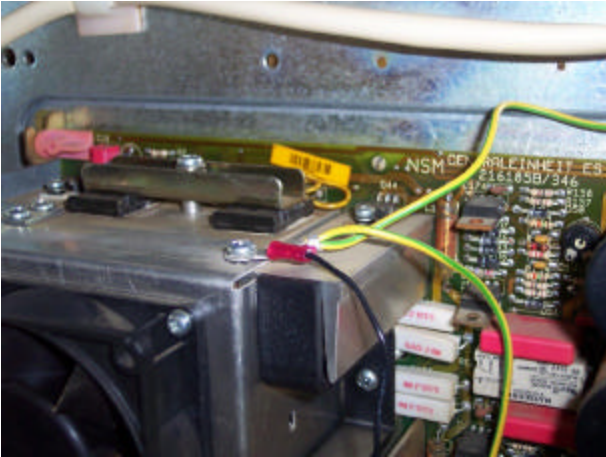

## Hooking Up The Digital Music Player To Your Jukebox

Assemble your hard disc drive to the MP3-DSP digital music player board. Place the board, back end first, into the enclosure then press down at the front. The foam pad is placed on the top cover, over the rear 9-pin connector to hold it down in place. Plug in the 9-pin mini DIN connector (arrow or notch at the top). Connect the power supply and jukebox interface cable to the MP3 player cable.

Attach the black wire (spade terminal) to the green/yellow ground wire screw, as shown at the left.

At the jukebox Control Unit board connector position ST12, unplug the 8-pin CD Mechanism connector and plug in the NSM5MP3's connector (white wire facing toward ST10).

Unplug the connectors at the back of the CD mechanism changer. Insert the 4-pin header from the MP3 player into the audio connector ribbon from the jukebox amplifier.

The MP3 player comes with its own power supply which operates from line voltages of 100 to 240 VAC. You may need to install an outlet cord if your jukebox is not equipped with a AC outlet.

The player can be set in any position. It is small enough to sit on top of the CD changer (in wall mount jukeboxes) or you can remove the CD player if you choose.

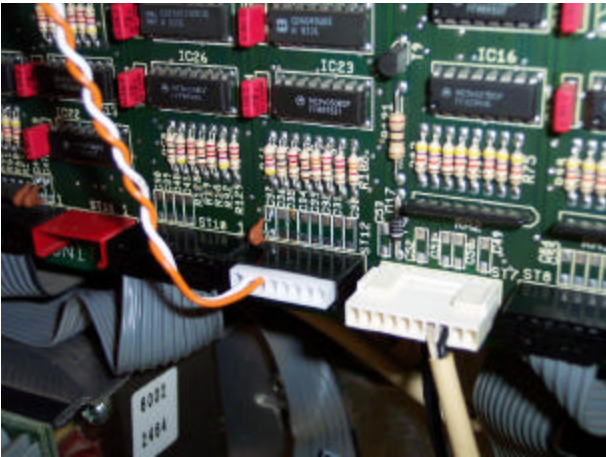

## Built-In Diagnostics

When the player is powered up, diagnostics are performed followed by song indexing. The LED will blink brightly during this time. Depending upon the number of songs, this can take up to a few seconds to complete.

If an error is detected, the LED will continually flash an error code of one to four blinks each,

- (1) INITIALIZATION ERROR, disk drive is not inserted correctly or MP3 player board failure.
- (2) FILESYSTEM ERROR, unable to locate FAT32 filesystem or drive was not formatted.
- (3) NO FOLDERS FOUND, a directory folder is used for each CD, check disk contents.
- (4) NO MP3 FILES FOUND, MP3 files are used for each audio track, check disk contents.

## Playing MP3 Songs

Your jukebox operates exactly as it did before, two digit disc number and two digit track number.

The jukebox and player are also capable of having up to 99 tracks for each disc but you may need to set parameter P042 to play tracks higher than 24. The first two digits are the maximum disc number and the next two are maximum track number. Factory setting is 0024 which is 100 discs having up to 24 tracks. For 99 tracks, change to 0099.

