

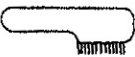





<u>PICTURE OF PART</u>	<u>DESCRIPTION OF PART</u>	<u>QTY</u>
	1 Billiard balls	1
	2 Brush	1
	3 Triangle	1
	4 Chalk	2
	5 Cue stick	2
	6 Leg Leveler	4
	7 Ball Storage	1
	8 1-1/8" Phillips head screw	4
	9 Main frame	1

Assembly Instructions

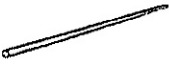
Step1:

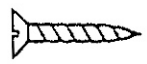

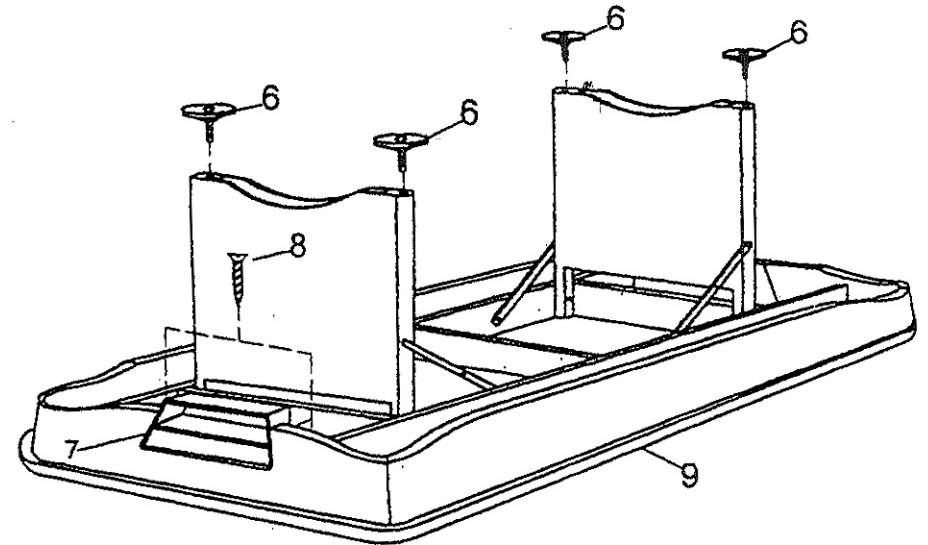
A.u.S. Spielgeräte GesmbH
 Scheydgasse 48 A-1210 Wien
 Tel. +43-1-271 66 00 Fax.+43-1-271 66 00 75
 E-mail: verkauf@aus.at
<http://www.aus.at>
 Öffnungszeiten: Mo-Fr. 9-18 Uhr