



A.u.S. Spielgeräte GesmbH
Scheydgasse 48 A-1210 Wien
Tel. +43-1-271 66 00 Fax. +43-1-271 66 00 75
E-mail: verkauf@aus.at
<http://www.aus.at>
Öffnungszeiten: Mo-Fr. 9-18 Uhr



BILLIARD TABLE







ITEM NO:9200.328

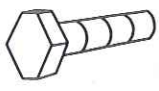
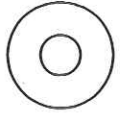
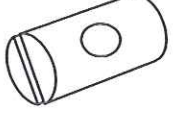
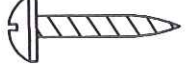
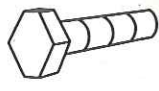
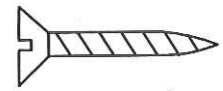

PART LIST

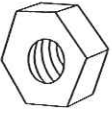
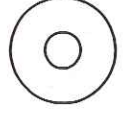
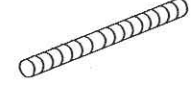
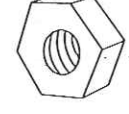
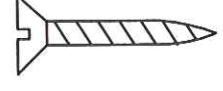
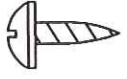
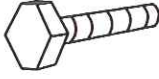
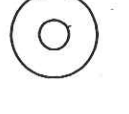

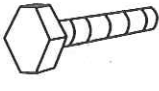
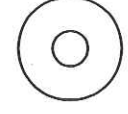
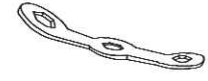
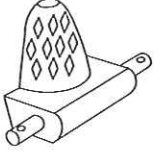
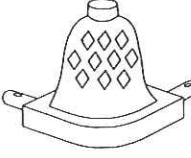
#1  3/8"X3" bolt 8 pieces	#2  3/8"X23mm washer 28 pieces	#3  3/8" Barrel nut 8 pieces	#4  T4X1-1/2" screw 8 pieces
#5  3/8"X1-3/4" bolt 16 pieces	#6  F4X2" screw 16 pieces	#7  5/16"X5-1/2" bolt 2 pieces	#8  5/16" nut 4 pieces
#9  5/16"X23mm washer 4 pieces	#10  3/8"X3" bolt 4 pieces	#11  3/8" nut 4 pieces	#12  #12X2-1/2" screw 12 pieces
#13  T4X12mm screw 28 pieces	#14  5/16"X1-1/8" bolt 12 pieces	#15  5/16"X19mm washer 12 pieces	#16  5/16"X19mm washer 12 pieces
#17  5/16"X1-3/4" bolt 18 pieces	#18  5/16"X35mm washer 18 pieces	#19  Wrench 1 piece	#20  Basket(A) 2 pieces
#21  Basket(B) 4 pieces			

STEP 1:

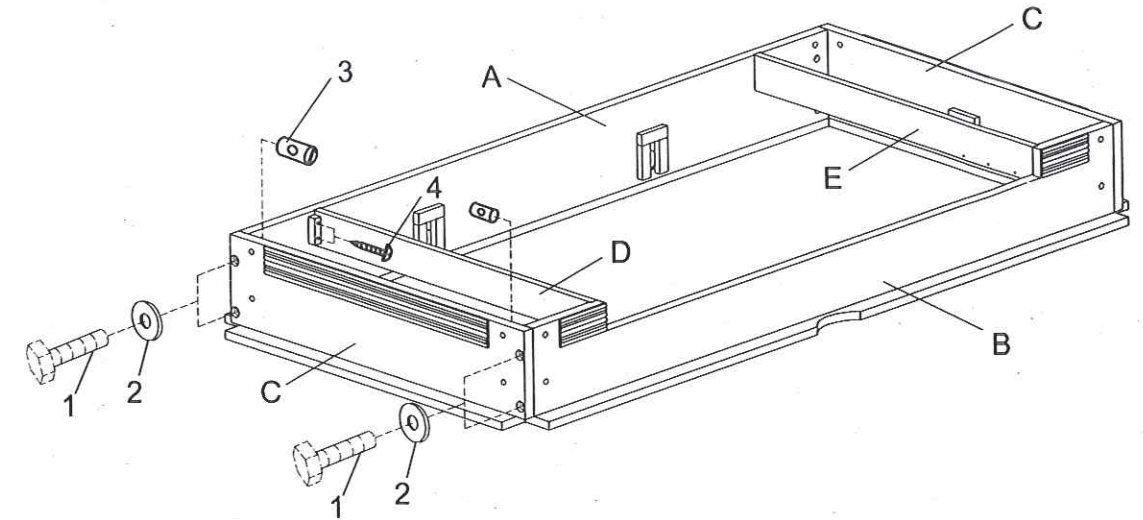

STEP 2:

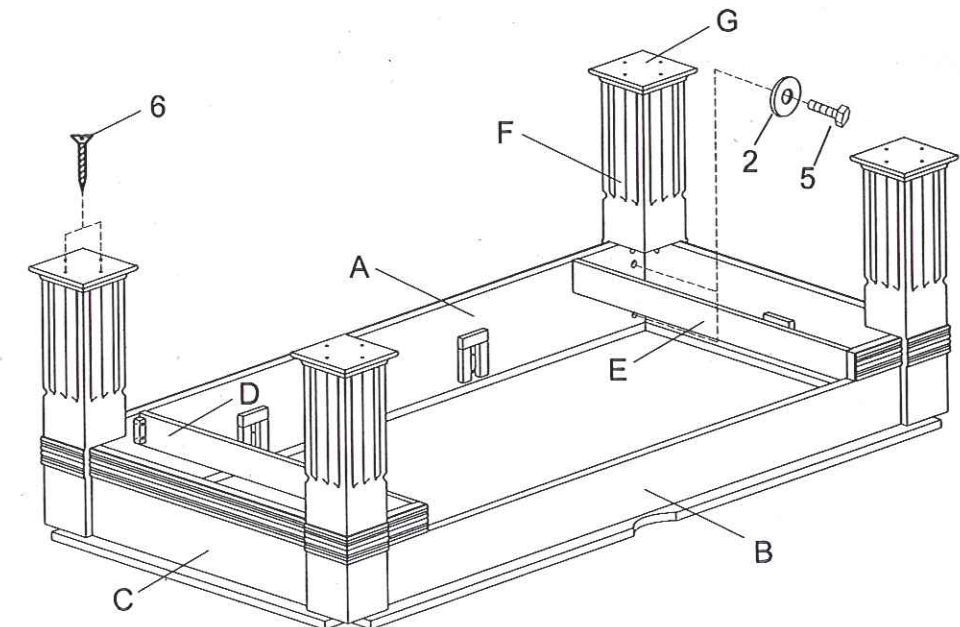



A.u.S. Spielgeräte GesmbH
 Scheydgasse 48 A-1210 Wien
 Tel. +43-1-271 66 00 Fax. +43-1-271 66 00 75
 E-mail: verkauf@aus.at
 http://www.aus.at
 Öffnungszeiten: Mo-Fr. 9-18 Uhr



A.u.S. Spielgeräte GesmbH
 Scheydgasse 48 A-1210 Wien
 Tel. +43-1-271 66 00 Fax. +43-1-271 66 00 75
 E-mail: verkauf@aus.at
 http://www.aus.at
 Öffnungszeiten: Mo-Fr. 9-18 Uhr







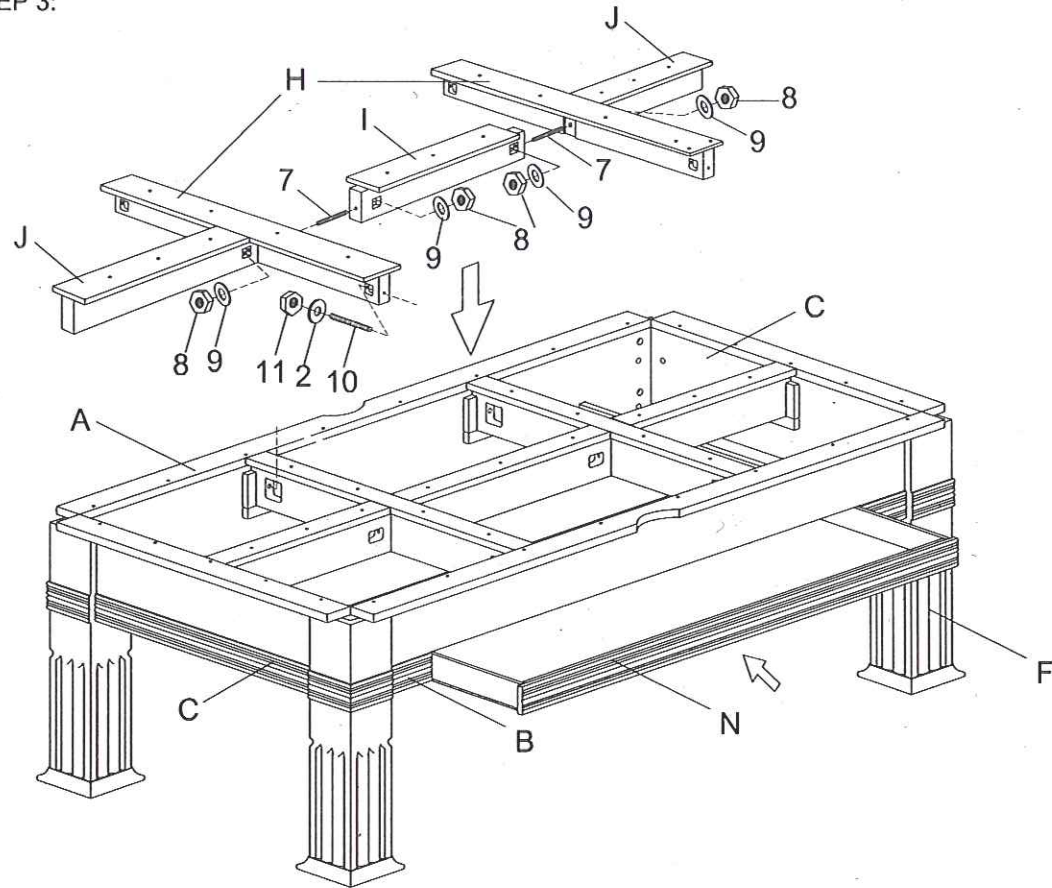



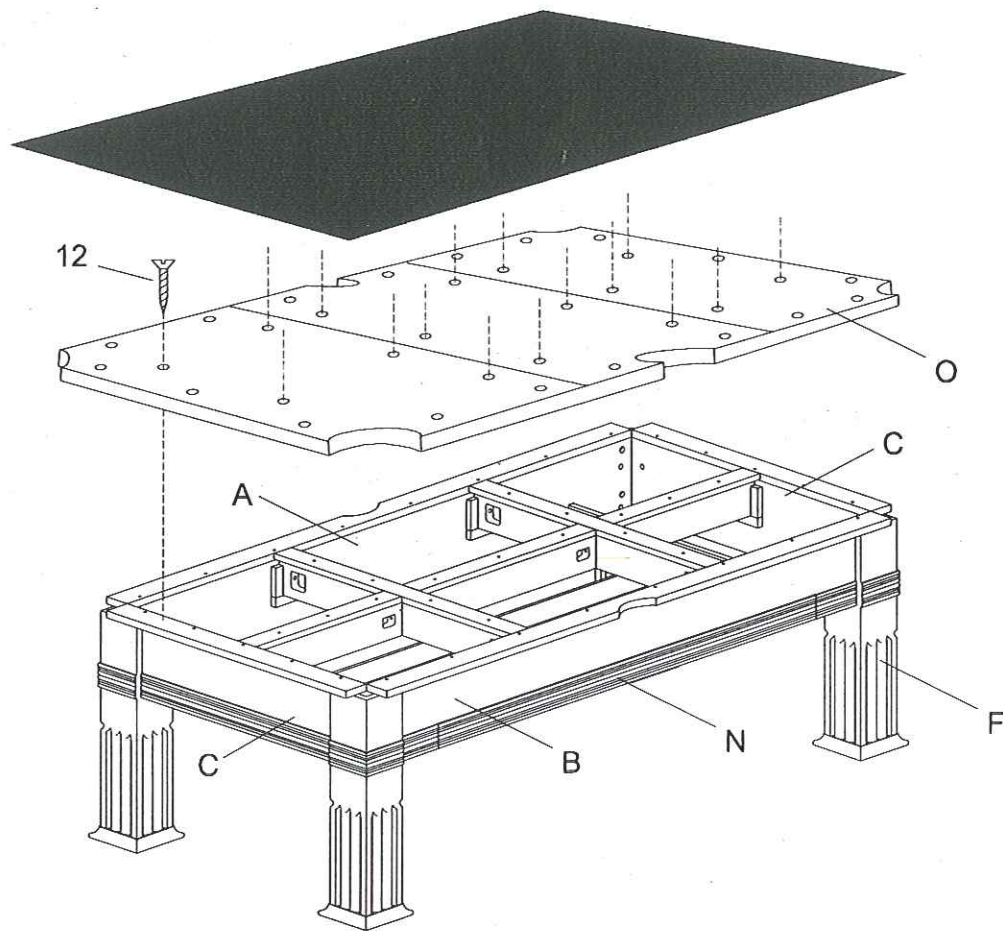

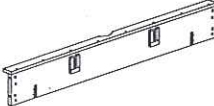
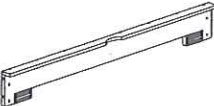
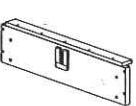
PART LIST

STEP 3:

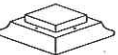
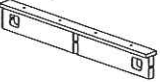
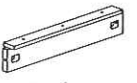

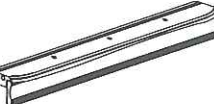
STEP 4:

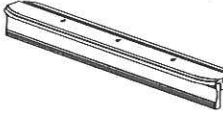

 1 piece	 1 piece	 2 pieces	 1 piece
 1 piece	 Leg 4 pieces	 Bun foot 4 pieces	 Beam A 2 pieces
 Beam B 1 piece	 Beam C 2 pieces	 Side rail A 2 pieces	 Side rail B 2 pieces
 End rail 2 pieces	 Drawer 1 piece	 Slate 1 set	

STEP 5:

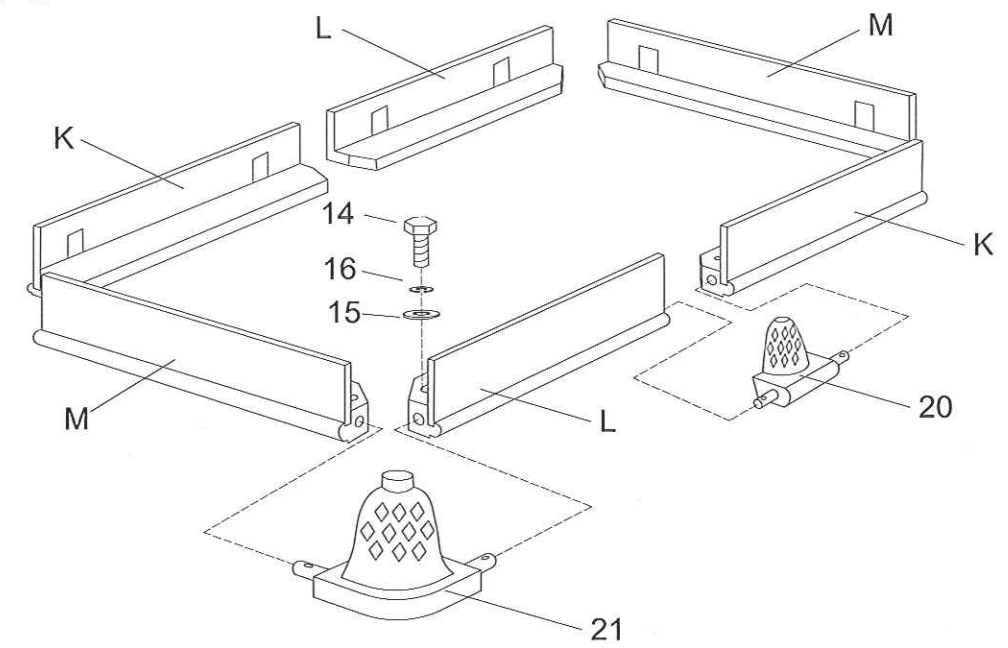

STEP 6:

