



A.u.S. SPIELGERÄTE GMBH  
SCHEYDGASSE 48, AT 1210 WIEN  
☎ +43 (0) 1 271 66 00 65 FAX +43 (0) 1 271 66 00 75  
🌐 www.aus.at ✉ verkauf@aus.at



# BILLIARD TABLE





ITEM NO:7190000027  
7190000028



A.u.S. SPIELGERÄTE GMBH  
SCHEYDGASSE 48, AT 1210 WIEN  
☎ +43 (0) 1 271 66 00 65 FAX +43 (0) 1 271 66 00 75  
🌐 www.aus.at ✉ verkauf@aus.at

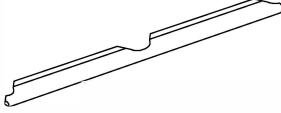

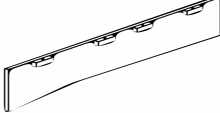
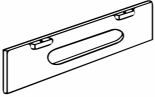
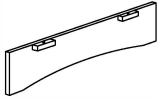
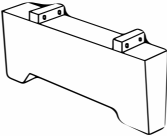
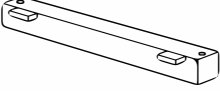
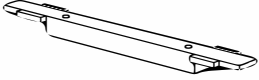
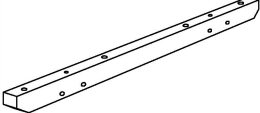
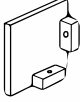
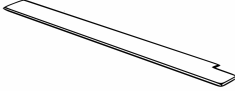
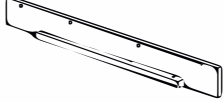





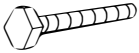
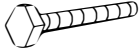
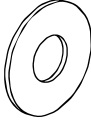
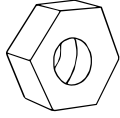
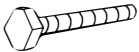
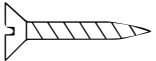
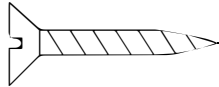

<p><b>A</b></p>  <p>Side rail 2 pieces</p>	<p><b>B</b></p>  <p>End rail 2 pieces</p>	<p><b>C</b></p>  <p>Side apron 2 pieces</p>	<p><b>D</b></p>  <p>End apron A 1 piece</p>
<p><b>E</b></p>  <p>End apron B 1 piece</p>	<p><b>F</b></p>  <p>Leg 2 pieces</p>	<p><b>G</b></p>  <p>End cross beam 2 pieces</p>	<p><b>H</b></p>  <p>Mid cross beam 2 pieces</p>
<p><b>I</b></p>  <p>Main beam 2 pieces</p>	<p><b>J</b></p>  <p>Ball storage panel A 2 pieces</p>	<p><b>K</b></p>  <p>Ball storage panel B 1 piece</p>	<p><b>L</b></p>  <p>Ball storage panel C 1 piece</p>

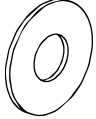
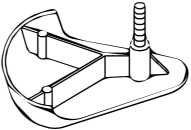
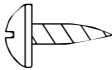

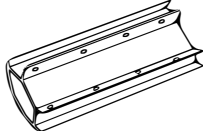
A.u.S. SPIELGERÄTE GMBH  
 SCHEYDGASSE 48, AT 1210 WIEN  
 ☎ +43 (0) 1 271 66 00 65 FAX +43 (0) 1 271 66 00 75  
 🌐 www.aus.at ✉ verkauf@aus.at

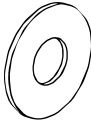
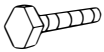
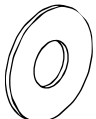
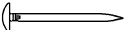

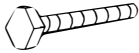
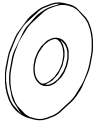
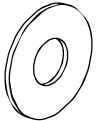
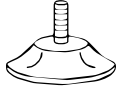
<p>#1</p>  <p>Ø10X130mm bolt 4 pieces</p>	<p>#2</p>  <p>Ø10X4-1/2" bolt 8 pieces</p>	<p>#3</p>  <p>Ø10X25mm washer 32 pieces</p>	<p>#4</p>  <p>Ø10 nut 16 pieces</p>
<p>#5</p>  <p>Ø10X180mm bolt 4 pieces</p>	<p>#6</p>  <p>F4X1-1/4" screw 4 pieces</p>	<p>#7</p>  <p>#12X2-1/2" screw 12 pieces</p>	<p>#8</p>  <p>1/4" nut 4 pieces</p>
<p>#9</p>  <p>1/4"X32mm washer 4 pieces</p>	<p>#10</p>  <p>End rail corner 4 pieces</p>	<p>#11</p>  <p>T4X1/2" screw 24 pieces</p>	<p>#12</p>  <p>Locker 4 pieces</p>
<p>#13</p>  <p>Apron corner 4 pieces</p>	<p>#14</p>  <p>5/16"X1-3/4" bolt 30 pieces</p>	<p>#15</p>  <p>5/16"X35mm washer 18 pieces</p>	<p>#16</p>  <p>1/4"X1-3/4" bolt 8 pieces</p>
<p>#17</p>  <p>1/4"X19mm washer 8 pieces</p>	<p>#18</p>  <p>Nail 26 pieces</p>	<p>#19</p>  <p>basket 6 pieces</p>	<p>#20</p>  <p>1/2"X5-1/2" bolt 4 pieces</p>
<p>#21</p>  <p>13X28mm washer 4 pieces</p>	<p>#22</p>  <p>5/16"X19mm washer 12 pieces</p>	<p>#23</p>  <p>Leg leveler 4 pieces</p>	

# Step 1:

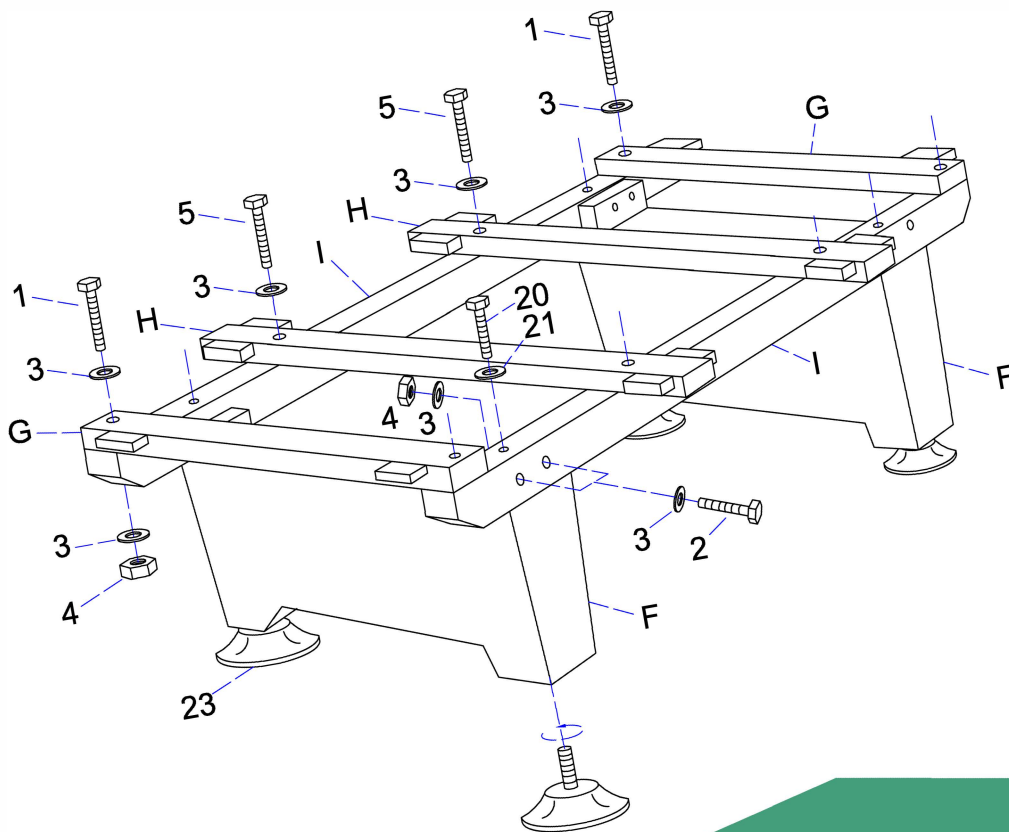

# Step 2:

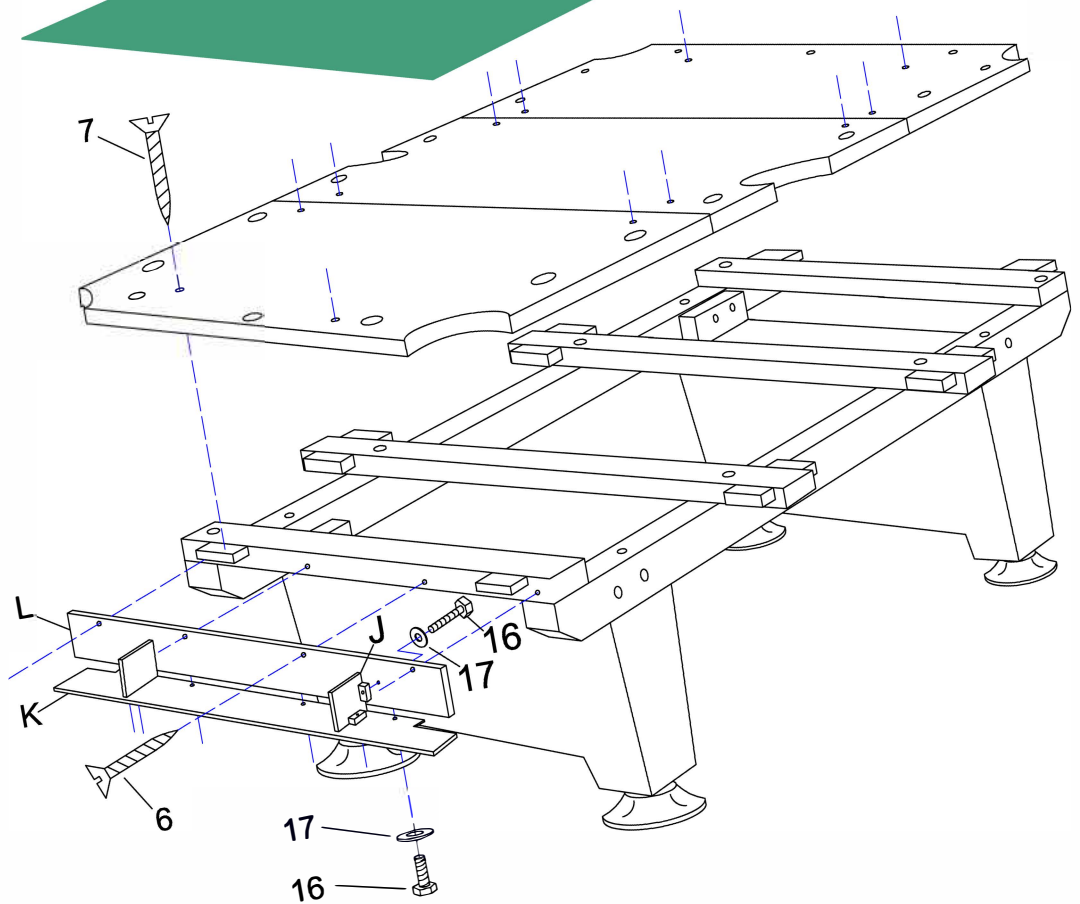

### Step 3:

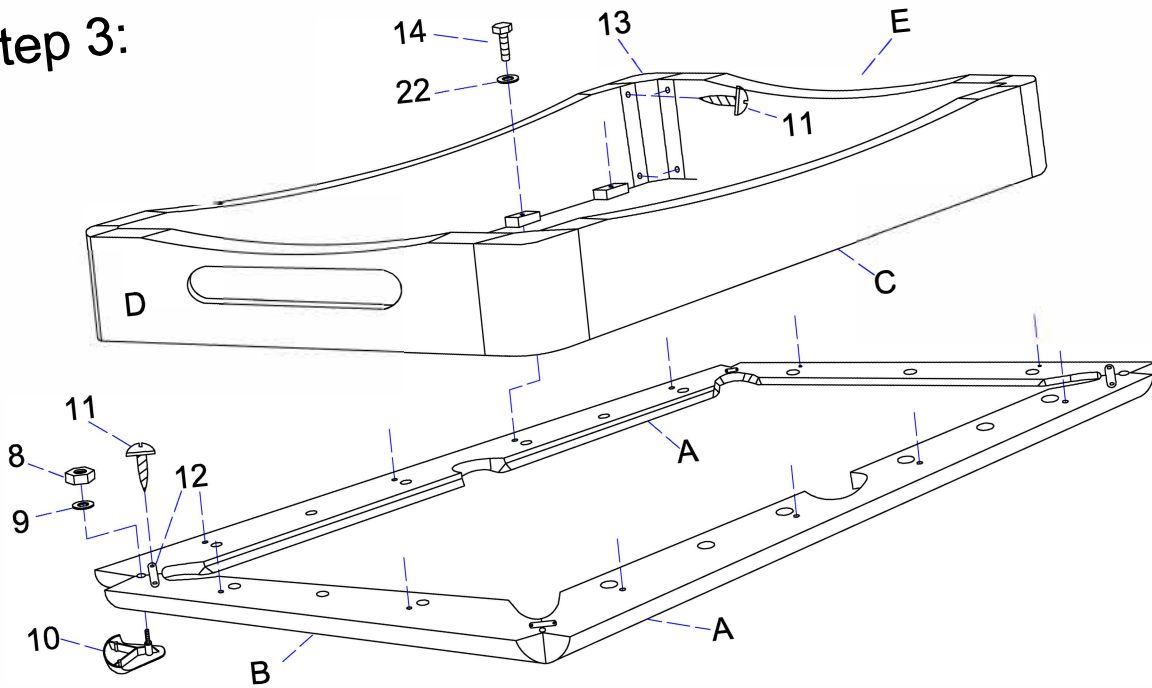

### Step 4:

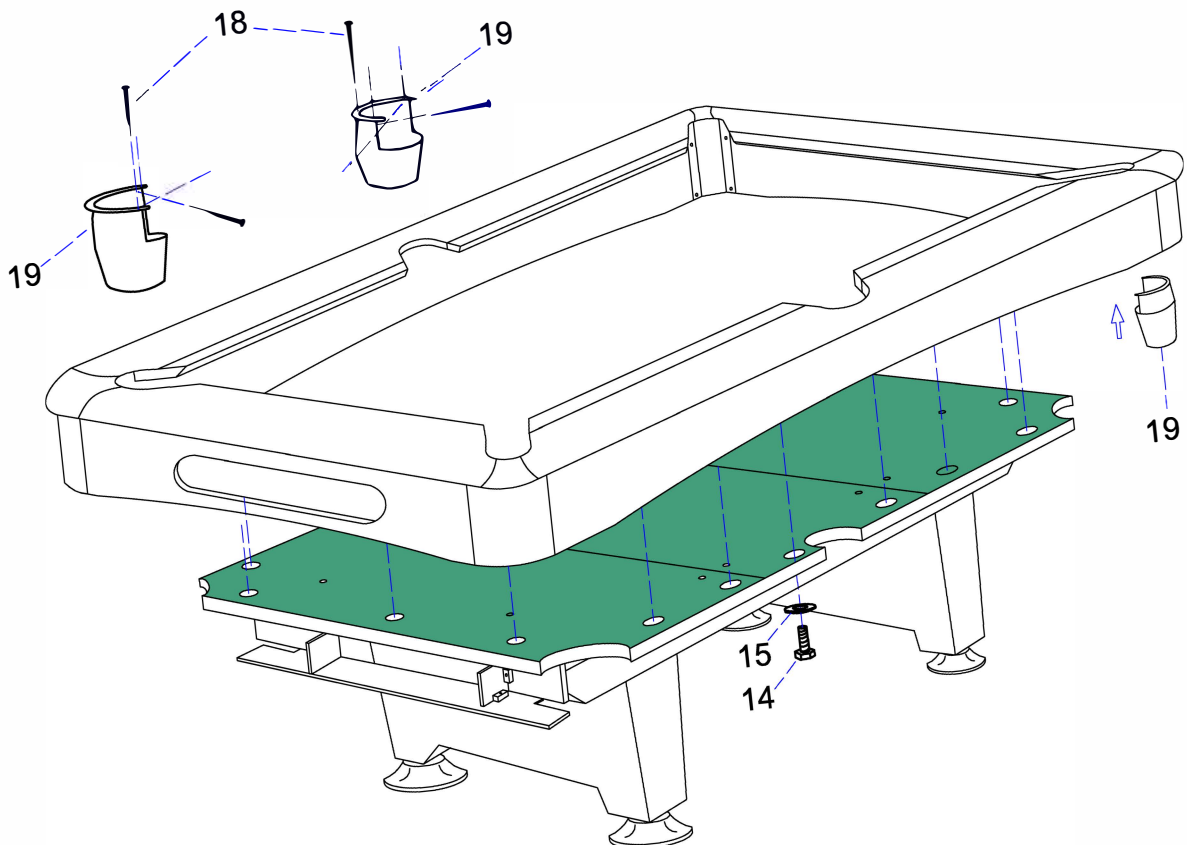

-END-